

PYLE[®] PRO

PYD-1002/PYD-1005
3 channel
trick
mixer

PERFORMANCE



owner's manual

Your PYLE PRO Series Performance Mixer

is a sophisticated control center, perfect for mixing sound from multiple playback sources such as microphones, tuners, CD players, turntables or the audio outputs from a VCR. This mixer is ruggedly constructed for home or professional use. Wide range volume controls permit you to adjust sound levels accurately to achieve just the right mix for playing through your speaker system or for recording.

Please read this manual thoroughly before you attempt to set up and use the mixer. It contains a range of suggestions and instructions to insure safe usage. Set up and used properly, you can expect years of trouble-free service from this product.

Owner's Manual Table of Contents

i	Input/Output Features	8	Using the Crossfader
1	Features and Controls: PYD-1002	9	Using the Tone Controls
2	Features and Controls: PYD-1005		Using the Kill Frequency Switches (PYD-1005)
3	Presetting Controls Before Use		Using the Zone Level Control (PYD-1005)
	Connecting the Outputs	10	Using the Master Balance Control (PYD-1005)
	Playing the Mixer's Output Signal		Using the Master Level Control
	Recording the Mixer's Output Signal		Dual Meter Modes
	Monitoring the Mixer's Output Signal in DJ Booth (PYD-1005)	11	Using the Punch Controls (PYD-1005)
4	Connecting the Mixer Inputs	12	Troubleshooting
5	Connecting the Lamp		Care and Maintenance
	Using Headphones	13	Specifications
6	Using the Mixer Controls		Warranty
8	Using the Microphone		

Input/Output Features: PYD1002/1005

Stereo Line Inputs let you connect most high-level audio sources, such as CD players, tape deck, tuner or VCR.

Output Jacks to connect the mixer to a receiver or amplifier – choose to use cables with either 1/4" jacks or RCA plugs.

Record Output Jacks to connect the mixer to a tape deck for recording the mixed program

Zone Output Jacks to connect the mixer to a second receiver or amplifier powering speakers in the DJ booth or in a remote location (PYD-1005)

PHONO Stereo Inputs for using a turntable with a magnetic cartridge

Ground Screw for turntables

MIC2 Microphone rear panel connector permits you to connect a balanced or unbalanced low impedance microphone with 1/4" plug.

Features and Controls: PYD1002 Mixer

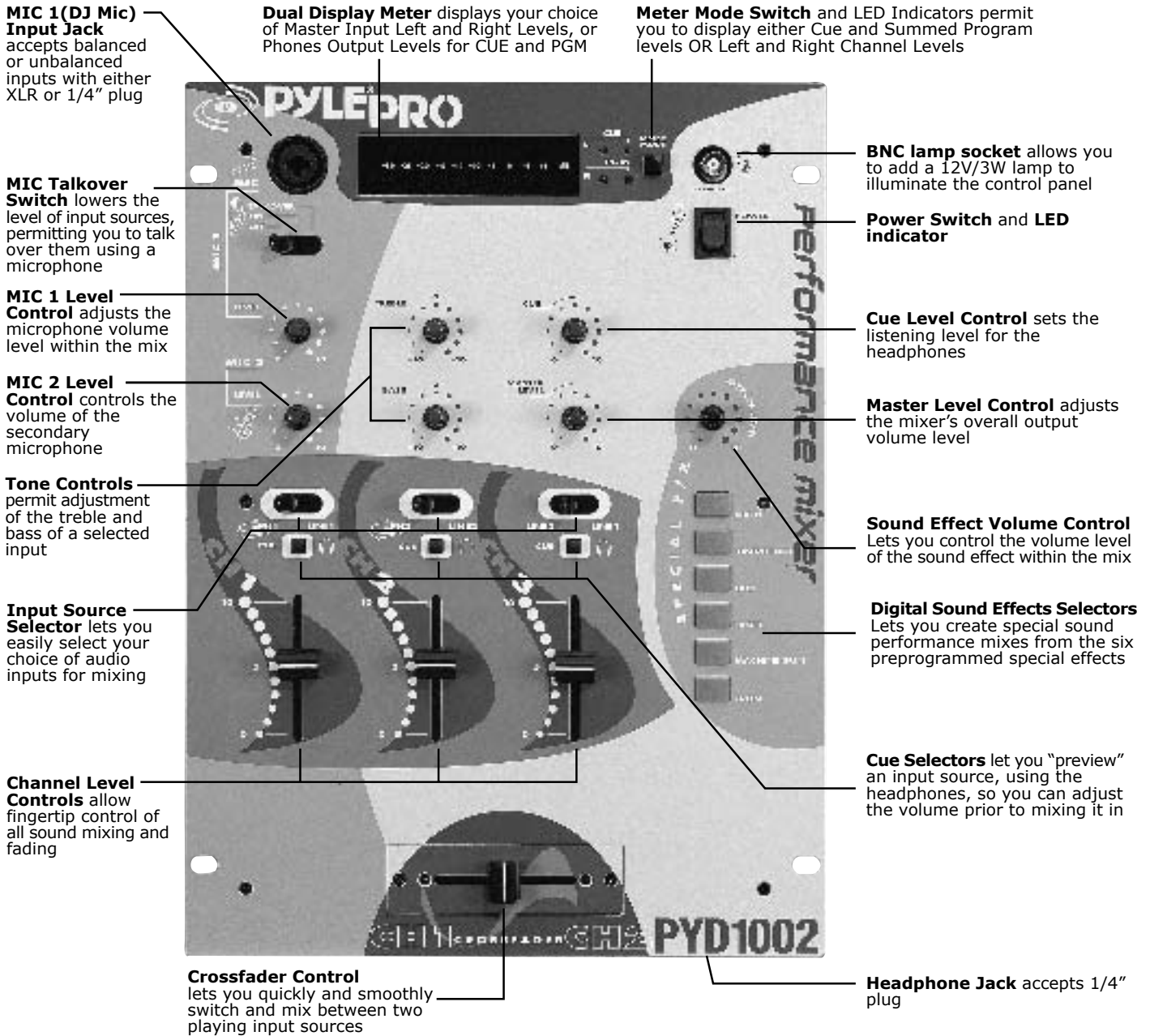

Features and Controls: PYD1005 Mixer

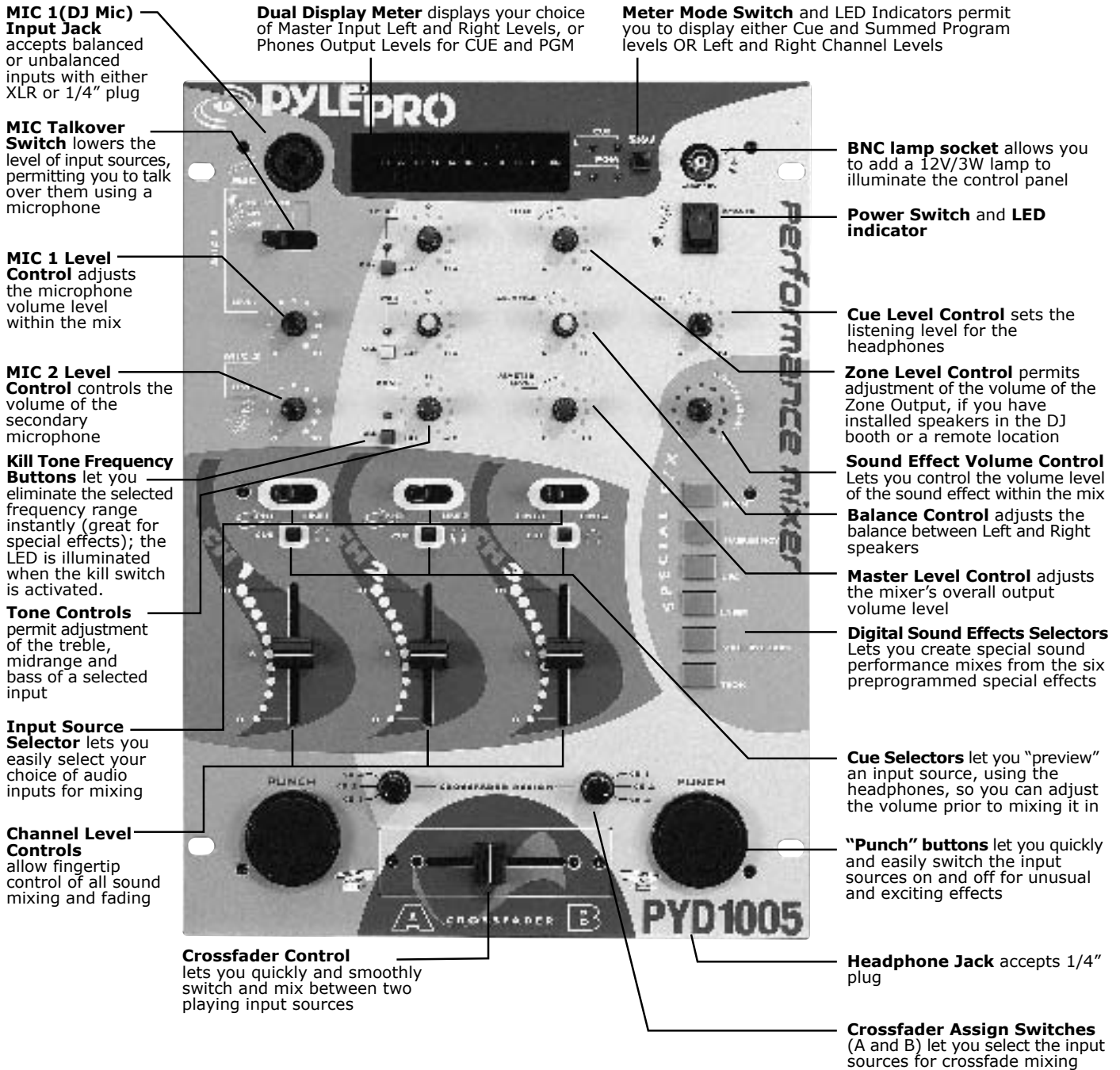

Presetting the Controls Before Use

Since sudden high output levels from your Pyle Pro mixer can damage not only audio devices connected to the mixer output but your hearing as well (especially if you are using headphones), please adjust the mixer's controls **BEFORE** connecting AC power or turning on the unit.

Set up the mixer controls like this before you start:

CONTROL	SETTING
Power On/Off	OFF
Balance	MID
Tone Controls, Treble, Mid and Bass	0
MIC 1/2, CH 1/2/3, Master and Cue Levels	0
Crossfader	CENTER

Connecting the Outputs

After presetting the controls (above), you can then connect the mixer's output jacks to the output devices' input jacks. Before connecting these devices, however, be sure to preset their controls to avoid any damage to your equipment due to unexpected high output levels.

Set the output devices' controls like this before you start:

OUTPUT DEVICE	CONTROL	SETTING
Tape Deck	POWER	OFF
Amplifier/Receiver	POWER	OFF
	tone	FLAT

Playing the Mixer's Output Signal

To play the mixer's output signal through your speaker system (for events such as parties, dances, conferences, etc.) connect an audio patch cord (not supplied) from the mixer's MASTER L and R jacks to your receiver's left and right input jacks. This mixer permits you to choose cables with either RCA jacks or 1/4" jacks for this connection, but do not use both sets of jacks simultaneously.

Recording the Mixer's Output Signal

To record the mixer's output signal, connect audio patch cords (not supplied) from the mixer's REC (Record) L and R jacks to your tape deck's left and right input jacks.

Monitoring the Mixer's Output signal in the DJ Booth

To monitor the mixer's output on a second set of speakers in the DJ booth (or in a remote location), connect an audio patch cord from the mixer's ZONE L and R jacks to the additional amplifier's left and right input jacks.(PYD-1005)

Connecting the Mixer Inputs

This mixer permits connection of up to eight (8) audio input sources, including up to two microphones. Such a system might include, for example:

- | | | |
|-----------------|--------------------|-------------------|
| Two Microphones | Two Microphones | Two Microphones |
| Two Turntables | Two Turntables | Two Turntables |
| Four CD players | Two CD players | Two CD players |
| | Two Cassette Decks | One Rhythm Synth |
| | | One Cassette Deck |

Please observe the following:

Do not connect any audio source with a *HIGH LEVEL OUTPUT* to the *LOW LEVEL PHONO 1* or *PHONO 2* mixer audio input jacks (an audio source output with a volume control is *HIGH LEVEL*).

Connect audio inputs as follows:

1. DJ Microphone. Connect the DJ's MIC 1 (not supplied) to the mic input jack in the upper left corner of the mixer control panel. The special combo jack permits you to connect with either a 1/4" plug or XLR plug.

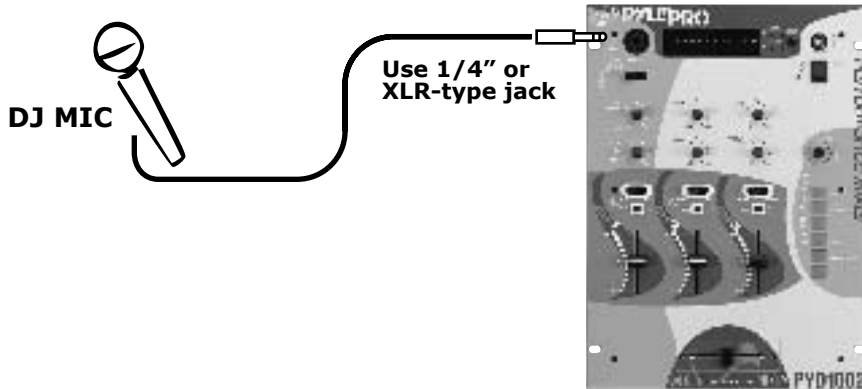

2. High Level Output Audio Sources. Connect up to 4 such sources (tuner, cassette deck, CD Player, camcorder or VCR) to the input jacks for Line 1, Line 2, Line 3 and Line 4.

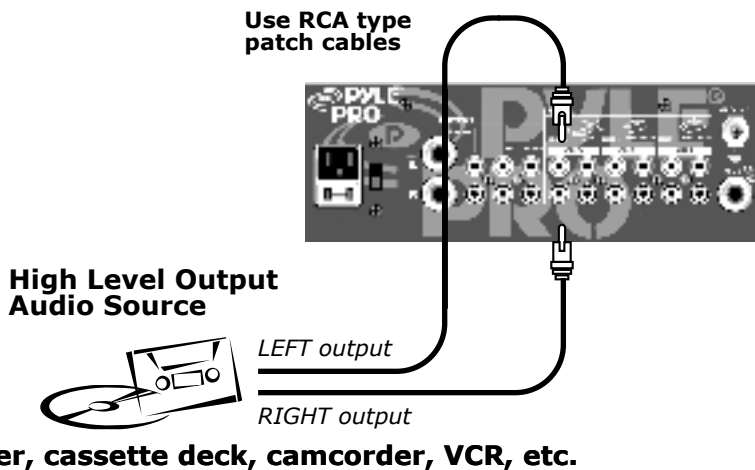

CD player, cassette deck, camcorder, VCR, etc.

Connecting the Mixer Inputs (cont.)

3. Turntables. Connect up to 2 turntables to the Phono 1 and Phono 2 input jacks.

When using a turntable, you should also securely connect its ground wire (usually green or black) to the Ground screw on the input panel of the mixer.

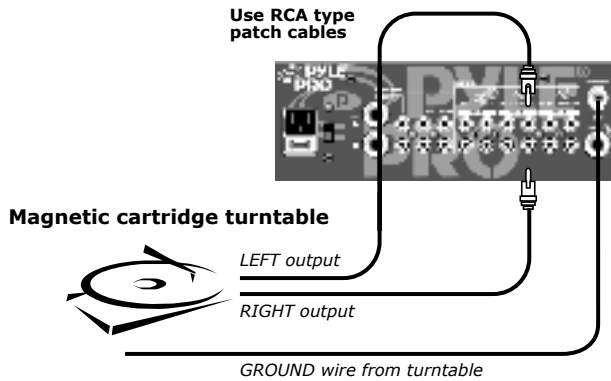

Connecting the Lamp

If you wish to install a console lamp (not supplied), simply insert the plug end of an appropriate 12V/3W gooseneck style or similar lamp into the lampsocket provided in the upper right corner of the mixer control panel. Power is supplied to this lamp when the mixer power switch is turned on.

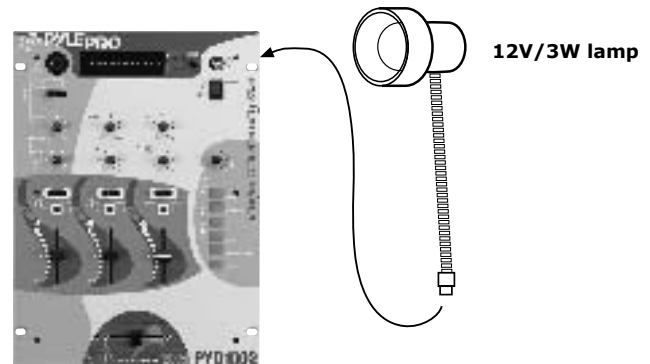

Using Headphones

Plug a pair of stereo headphones (not supplied) with a 1/4" plug into the Phones output. Using headphones not only affords you the opportunity to listen privately, but also enables you to monitor the incoming audio sources so you can locate an exact passage or section before mixing it in. It also gives you the opportunity to set up the relative volume level of the upcoming passage before it joins the mix.

Listen Safely! Please observe the following:

Do not listen at extremely high volume levels. Extended, high-volume listening can lead to permanent hearing loss. Follow these guidelines to protect your hearing, especially when using headphones.

Always start by setting the volume level to the lowest possible level before listening.

Put headphones on, and then gradually increase the volume as necessary.

Once you set the volume level do not increase it. Over a period of time, your ears adapt to a volume level and there is a temptation to increase it. Even though such an increase may not cause discomfort, it might still damage your hearing.

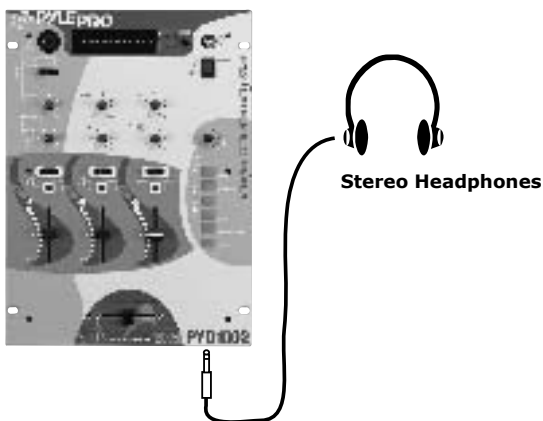

Using the Mixer Controls

Turning on the Mixer

1. Turn on the output amplifier and temporarily set its volume to the minimum setting.
2. On the mixer, turn ON the power switch. The adjacent power LED will illuminate.
3. Turn on the audio input sources you wish to mix, and set them to play (or talk continuously into the microphone).
4. To monitor the audio input sources so that you can decide when to mix in each input, see "Monitoring 'Cueing' the Inputs."
5. To mix the audio input sources so that you can play them through your amplifier system or record them on your tape deck, see "Mixing the Inputs."

Monitoring ("Cueing") the Inputs

Follow these steps to monitor the audio input sources.

1. Perform Steps 1 and 2 of "Turning on the Mixer" and put headphones on.
2. Set the CUE switch of the input source (CH1, CH2 or CH3) to the ON position.

CUE switch

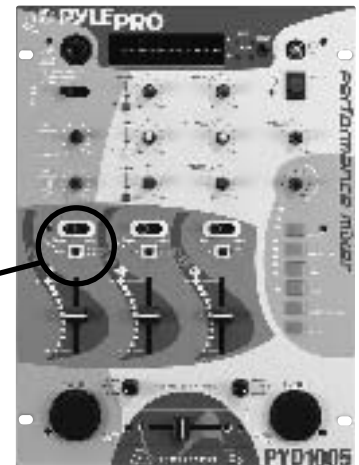
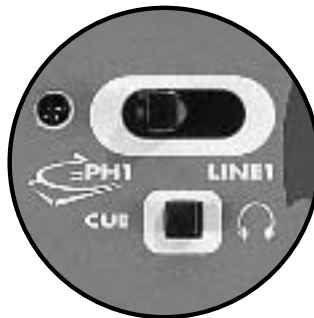

3. Set the desired audio input source's volume to its minimum setting, turn it on, and set it to play (or speak continuously into the microphone).
4. Slowly turn the CUE LEVEL control clockwise until you hear the signal through the headphones at the desired volume level.

CUE Level Control

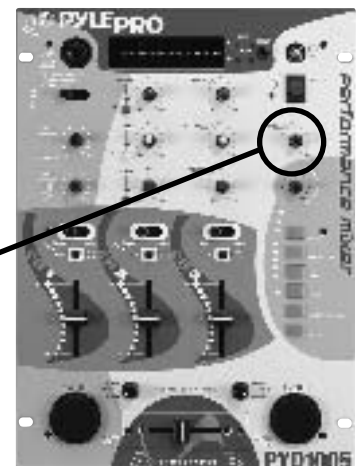
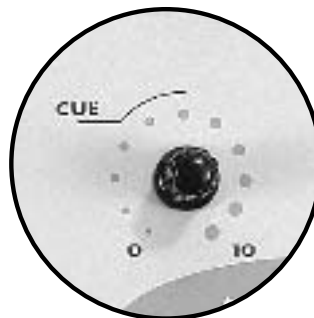

5. Repeat Steps 2-4 to select and adjust the volume level of the other audio input sources, one at a time.

Mixing the Inputs

Follow these steps to mix the audio input sources.

1. Perform Steps 1 and 2 of "Turning on the Mixer."
2. Set the selected audio input source's volume to its minimum setting, turn it on, and set it to play (or speak continuously into the microphone).
3. Set the following input source selectors as desired:



Input Source Selector Switches

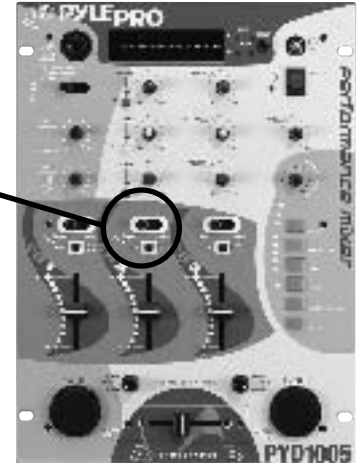

Mixer Channel	Audio Input Source
1	Turntable connected to PHONO1
	High level output audio source connected to the LINE 1 jacks
2	Turntable connected to PHONO2
	High level output audio source connected to the LINE 2 jacks
3	High level output audio source connected to the LINE 3 jacks
	High level output audio source connected to the LINE 4 jacks

4. Set the Channel 1, Channel 2 and Channel 3 volume control sliders to approximately 8-10.
5. Rotate the Master Volume Control clockwise until you observe an average reading of "0" (zero) on both Output Level LED meters, and leave it at that setting. (Please note that the Output Level LED meter indicates the total output signal being mixed from all sources for each of the Left and Right channels.)
6. When adding an audio input source to the mix, adjust the corresponding Channel 1, 2 and 3 volume control sliders so you maintain the average reading of "0" on both Output Level LED meters.
7. Adjust the receiver/amplifier volume control to the desired volume.
8. To turn off the mixer, push the Power switch to the OFF position; the Power LED will be extinguished.

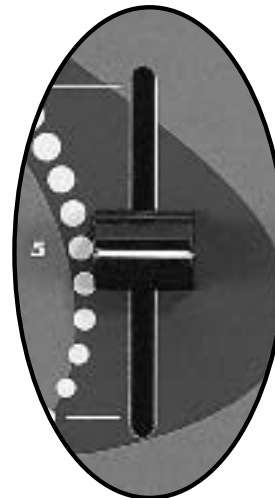

Input Source Volume Control Sliders

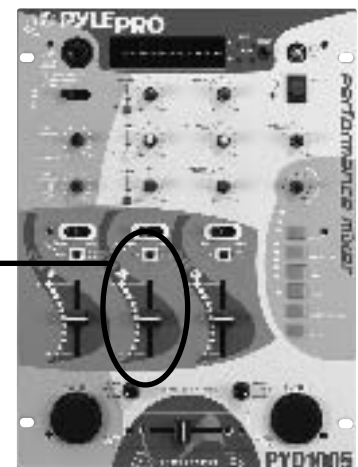

Using the Microphone

Incorporating Voice into the Mix

To blend voice from the microphone with the audio program material, adjust the turn the MIC 1 Talkover Switch to ON and use the MIC1 level slider to increase or decrease the microphone level. This will not affect the main volume inputs. When the microphone is not in use, set the MIC level slider to "0."

Talkover Mode

Talkover mode allows a voice to be heard clearly through the microphone by attenuating all the other audio input sources. This mode is engaged by setting the Talkover Switch to the TALKOVER position. When not using the microphone, set this switch to the OFF position.



Talkover Switch

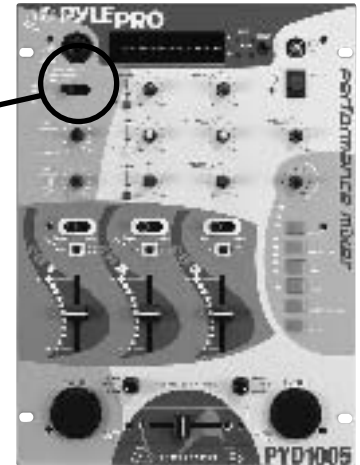

Using the Crossfader with the Assign Switches

For crossfading effects, you can assign any of the three channels to either A or B sides of the crossfade mix using the Crossfade assign knobs.

When the crossfade slider is in the center position, the two assigned channels play equally. Sliding the control towards the A position will increase the level of A and fade out B proportionally to the distance from center. Likewise, sliding the control towards the B position will increase the level of B and fade out A.

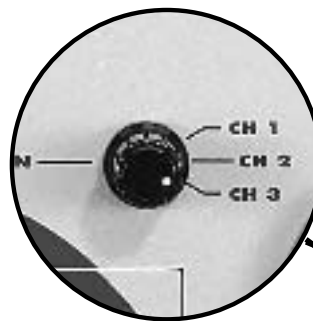

Crossfade Assign Switches

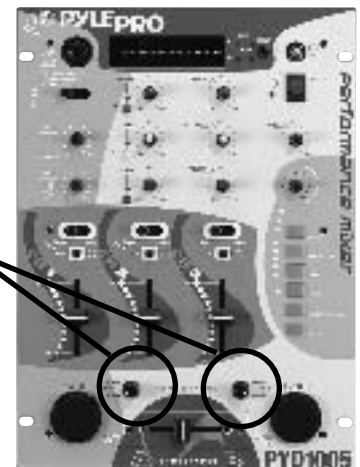

Using the Tone Controls

To enhance the sound or tailor the highs, mids (PYD-1005) and low frequencies for audio source input to the acoustics of a particular performance environment, you can adjust the BASS, MID (PYD-1005) and TREBLE tone controls. Rotating the bass control, for example, will boost the bass frequencies in the bass range.



Tone Controls

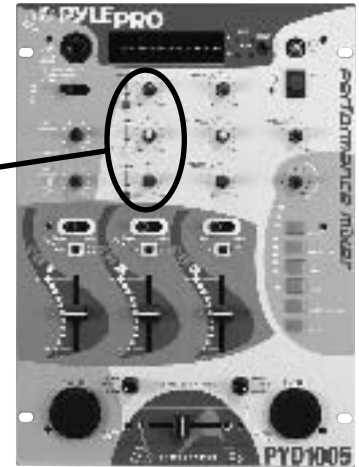

Using the Frequency Kill Switches

For unique circumstances or interesting special effects, you can completely eliminate the bass, mid or treble frequency range from selected input by pressing the Kill button for that range. When the Kill mode is active, the LED above the button will be illuminated.

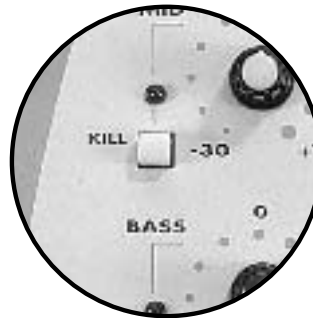

Frequency Kill Switches

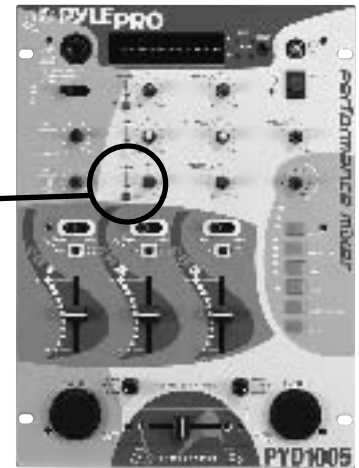

Using the Zone Level Control

If you have a separate set of monitor speakers in the DJ booth or in a remote location, you can adjust the output level to these speakers using the Zone Level control. Zone speaker level is controlled independent of the Master Level control.



Zone Level Control

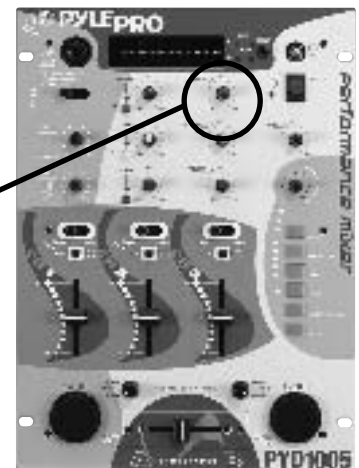

Using the Master Balance Control (PYD-1005)

In the typical performance environment, you will want the sound to appear to be coming from a point midway between the speakers. If the sound appears to be louder from one speaker, adjust the Balance Control until the sound is properly balanced.

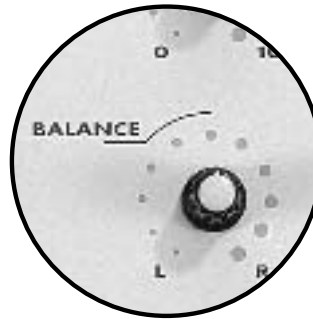

Master Balance Control

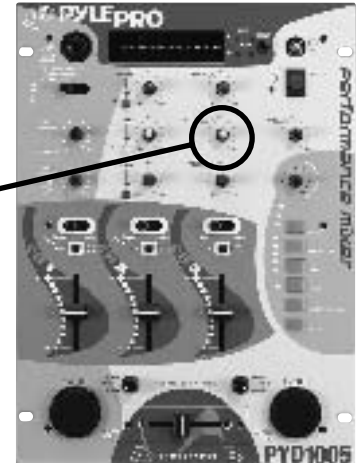

Using the Master Level Control

The overall volume of the mix of all inputs is adjusted using the Master Level control. Turning this control clockwise increases the overall system volume.



Master Level Control

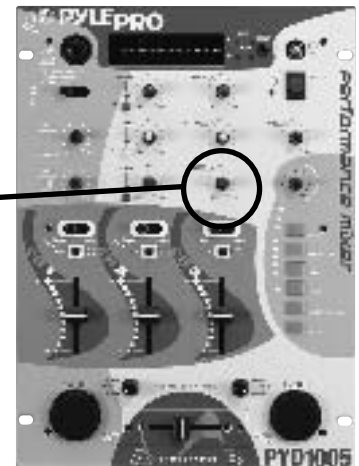

Changing and Viewing the Dual Meter Modes

Your mixer's Dual Meter Mode feature allows you to view the levels of each of the left and right channels in the current mix, or to view the cued (upcoming) program level compared with the current mix (summed).

To change the current display, press the Meter Mode button. The LEDs immediately to the left of the button indicate the current meter mode.

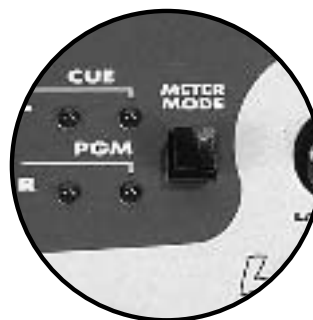

Meter Mode Switch

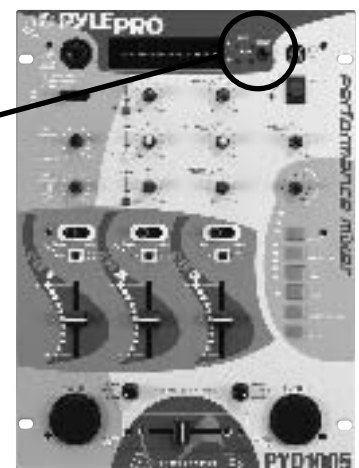

Using the "Punch" Controls (PYD-1005)

This featured control lets you smoothly and quickly turn a playing source on and off, or switch between the two different input sources assigned to Crossfade Channel A and B.

The effect you get depends upon the position of the Crossfader.

With the Crossfader at 100% Channel A (all the way to the left), pressing the Channel A Punch Button will mute the Channel A material.

Similarly, with the Crossfader at 100% Channel B (all the way to the right), pressing the Channel B Punch Button will mute the Channel B material.



Punch Control

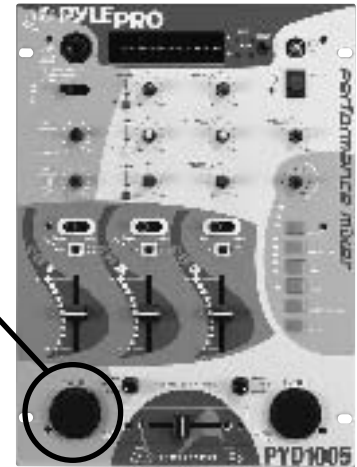

With the Crossfader in the middle position, press the Channel A punch button and the Channel A material will be subtracted from the mix, leaving only Channel B material. Likewise, press the Channel B punch button and the Channel B material will be subtracted from the mix.

Using the Sound Effects (PYD-1005)

There are pre-programmed sound effects for your selection. Press and hold any button to generate a sound which is added to the mix. The sound will play continuously until you release the button.

Troubleshooting

Your mixer should require very little maintenance. If you have problems, refer to the chart below for possible solutions. If you cannot solve the problem, contact a qualified technician for assistance.

PROBLEM	POSSIBLE SOLUTION
Nothing works	<ul style="list-style-type: none"> • Check the AC connection. Make sure the AC outlet is "live." • Check the power connection to the rest of the system (receiver/amplifier, etc.)
No signal from an audio input source	<ul style="list-style-type: none"> • Check the control setting • Check the connection between the mixer and the input source
Hum from PHONO	<ul style="list-style-type: none"> • Check that the turntable's ground wire (usually black or green) is fastened securely to the GROUND SCREW on the mixer input panel
Hum from other source	<ul style="list-style-type: none"> • Make sure there are no low level inputs connected to the LINE input jacks
Feedback is present	<ul style="list-style-type: none"> • Move the microphone further away from the output speakers, or use a directional microphone

Care and Maintenance

Your Pyle Pro Mixer is an example of superior design and craftsmanship. The following suggestions will help you care for your mixer so you can enjoy years of use:

- Keep the mixer dry. If it gets wet, wipe immediately.
- Use the mixer only in well-ventilated installations.
- Handle the mixer gently and carefully - do not drop!
- Keep the mixer away from dust and dirt.
- Wipe occasionally with a damp cloth to keep it looking new. Do not use harsh chemicals, solvents or detergents!

▼ Please complete warranty card, detach and return ▼

Place Stamp Here

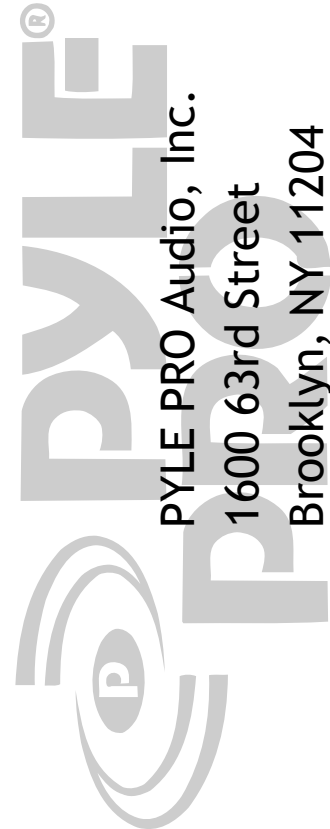

Specifications

PYD1002/1005

Input Sensitivity/Impedance

Mic	1.5 mV/600 Ohms
Phono 1-2	3.0 mV/50K Ohms
Line 1-4	150.0 mV/27K Ohms

Output Level

Master	1.5 V/10-kOhms
Zone(PYD-1005)	1.5 V/10-kOhms
Record	150mV/10-kOhms

Frequency Response 20Hz – 20kHz +/- 3 dB

S/N Ratio (at 1 kHz)

Mic	55 dB/1.5mV input
Phono	65 dB/3.0mV input
Line	70 dB/150.0 mV input

Distortion

Mic	0.50%
Phono	0.08%
Line	0.05%

Tone Control

Treble	10kHz; +10/-30dB(PYD-1005) 10kHz; +10/-10dB(PYD-1002)
Mid(PYD-1005)	1 kHz; +10/-30dB
Bass	100Hz; +10/-30dB(PYD-1005) 100Hz; +10/-10dB(PYD-1005)

Talkover Attenuation -16dB

Power Source 120 VAC, 60Hz/230 VAC, 50 Hz

Dimensions, inches (mm) 10.25 x 3.6 x 14.0 (260 x 92 x 355)

Weight, lbs (kg) 8.8 (4)

Thank you for purchasing this PYLE product. To activate your warranty, please mail this card within 10 days.

PYLE PRO MIXERS

warranty registration card

Please complete warranty card, detach and return

Limited Warranty

All PYLE PRO products are carefully constructed and tested before shipment. Units purchased in the USA are warranted to be free of defects in material and workmanship for two (2) years from the date of purchase. This warranty is limited to the original retail purchaser of the mixer.

Should the unit fail due to factory defects in material or workmanship, your unit will be repaired or replaced at the sole discretion of PYLE.

To obtain warranty service, you must first call our Consumer Return Hotline at (718) 236-6948 to obtain a Return Authorization Number. This R.A. # must appear on the outside of your package and on all paperwork relating to your return.

When returning the unit to us for warranty service, it must be carefully packed and shipped, prepaid, to:

R.A.#: _____
 PYLE PRO Service Center
 1600 63rd Street
 Brooklyn, NY 11204

You must also include the following items with your return:

- A copy of your sales receipt or other proof of purchase
- A brief letter, indicating the problem you are experiencing with the product
 - Include in your letter your return address, daytime phone number and R.A. number
 - Also include a check or money order for \$15.00 for return shipping, handling and insurance, or provide your Visa/MC number with expiration date.

Our obligation under this warranty is limited to the repair or replacement of the defective unit when it is returned to us prepaid. This warranty will be considered void if the unit was tampered with, improperly serviced or subject to misuse, neglect or accidental damage.

Purchased at:

Music Products Store

Sound Contractor/Installer

Mail Order

Catalog Merchandiser

Other _____

Name _____

Address _____

City, State ZIP _____

Model No. _____

Date of Purchase _____

Serial # (if available) _____